

THE ANDELA PULVERIZER

*It's why
cost-effective
glass recycling
breaks down
to this!*







WE'RE DEDICATED TO RECYCLING GLASS...

It costs time and money to process glass for closed and open-loop recycling, but you'll save substantial amounts of both with The Andela Pulverizer System. This compact, inexpensive system turns large volumes of glass into "sand." And it does the job at incredible speed!

 **Systems sized for up to 20 tons per hour.** The Andela Pulverizer handles any type and size of glass you can feed it, virtually as fast as you can load it in.

 **Accepts any glass.** Process your mixed-broken glass. There's no need to sort colors, remove labels, plastic or metal caps unless beneficiation level demands it. The Andela Pulverizer System reduces the glass and leaves other materials uncrushed for easy separation.

 **Makes glass "sand."** The Andela Pulverizer System produces a glass aggregate ranging from 10 to 1 mm in size. You can use it in your children's sandbox - no sharp edges!

 **Adaptable to any application.** The Andela Pulverizer System can be tailored to virtually any situation, and integrated into most any operation.





...NOT YOUR MONEY.

 **Competitively priced.** Why spend top dollar for a system with only a fraction of The Andela Pulverizer's capacity and efficiency! Dollar-for-dollar and pound-for-pound of material processed, The Andela Pulverizer System is the most economical, effective and efficient system on the market today.

THE ANDELA PULVERIZER

 **Designed for reliability.** The patented, flexible impact mechanism of our machine is engineered for long life and easy maintenance. There's no wear-inducing grinding action. Heavy-duty bearings are sealed and isolated, and all moving parts are easily accessible and replaceable.

 **Produces Cubic Aggregate for new Products.** The Andela Trommel Screen separates glass-sand into two aggregate sizes for use as a sand and gravel substitute in glassphalt, drainage or fill, decorative landscaping and water filtration.

 **Proven Performance.** "We've found the Andela Pulverizer to be outstanding. Given the price and the exceptional volume reduction, we feel it's the best machine to purchase."
--Margaret Pahio, Recycling Systems, Hawaii.



THE ANDELA PULVERIZER SYSTEM

Non-glass material uncrushed for easy separation.

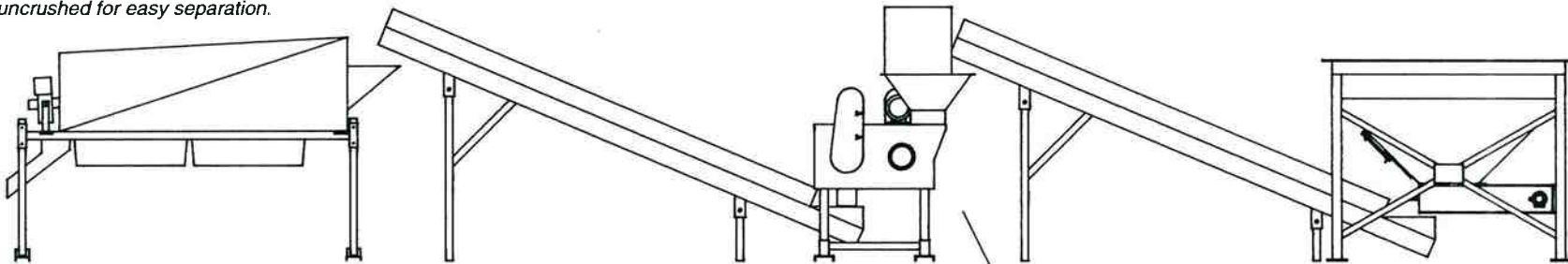

No other system in its class offers you the performance and price advantages of the Andela Glass Pulverizer System. Make one a part of your glass recycling system today.

Both you and your budget will be glad you did.

Accepts any size or type of glass for processing.

All moving parts easily accessible from outside.

High-volume systems process up to 20 tons per hour.

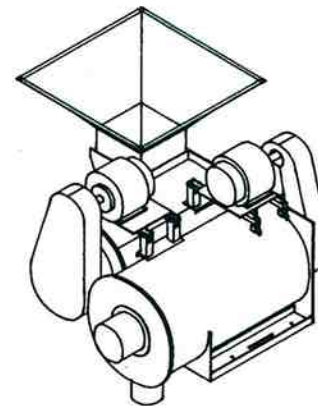

Makes aggregate 10 to .1 mm in size with high-efficiency flexible impact mechanism.



Call for additional information and pricing.

493 State Route 28, Richfield Springs, NY 13439
 Phone: (315) 858-0055 Fax: (315) 858-2669 E-mail: andela@recycle.net
 On the World Wide Web: <http://www.andelaproducts.com>